

3/8" – 1/2" INJECTION VALVE

COMPREHENSIVE VIEW AND FEATURES

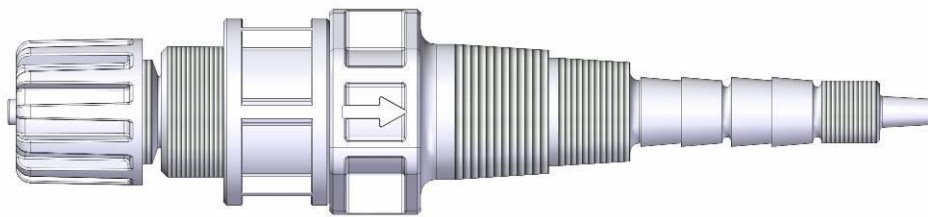





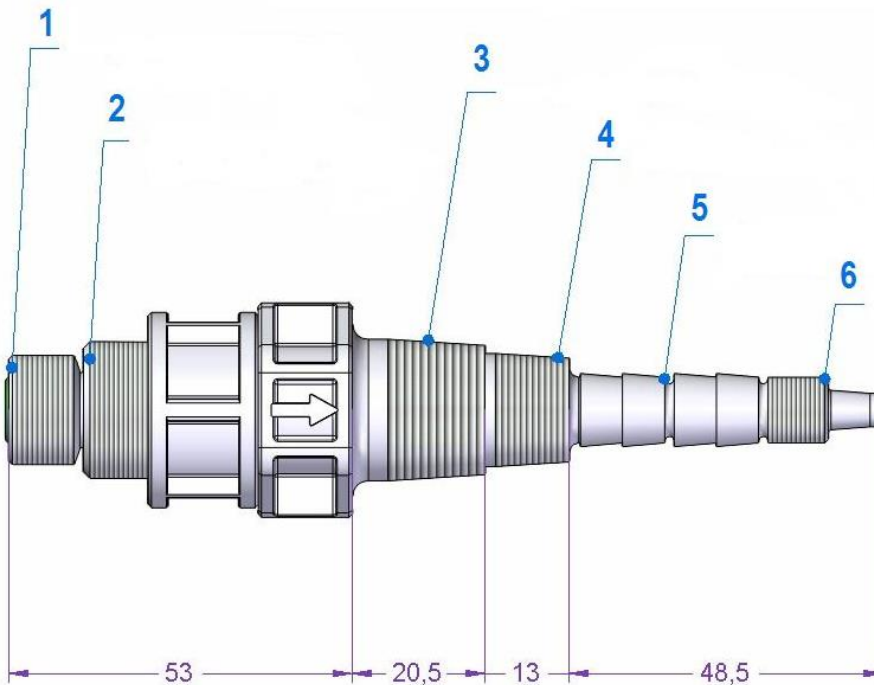



STANDARD CONFIGURATION

OVERALL DIMENSIONS AND CHARACTERISTICS

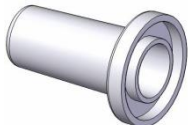

- 1 3/8" pump connection
- 2 1/2" pump connection
- 3 1/2" pipeline connection
- 4 3/8" pipeline connection
- 5 pre-cut extension
- 6 M10x1 threaded connection

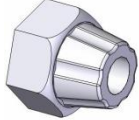
VALVOLA INIEZIONE 3/8" - 1/2"
3/8" - 1/2" INJECTION VALVE

<i>Kit contents</i>		
<i>FIG. / REF.</i>	<i>DESCRIPTION</i>	<i>Q.TY</i>
	<i>INJECTION VALVE</i>	1
	<i>TUBE BUSH 6x8</i>	1
	<i>TUBE NOZZLE 6x8</i>	1
	<i>NIPPLE 1/2"</i>	1
	<i>TUBE BUSH 10x14</i>	1
	<i>TUBE NOZZLE 10x14</i>	1
	<i>NOZZLE O-RING 10x14</i>	1
	<i>SPACER SPRING</i>	1
	<i>M10x1 TUBE NUT</i>	1
	<i>FLEXIBLE HOSE 4X6</i>	<i>NOT SUPPLIED</i>

3/8" – 1/2" INJECTION VALVE

Configurations

VALVE OPENING LEVEL OPTION	
<p>Exploded view</p>	<p>1. <i>SPRING</i> (PVDF) CONFIGURATION A (STANDARD):</p> <ul style="list-style-type: none"> • <i>D9,5 ball</i> • <i>opening pressure: < 0.1 bar</i> <p>2. <i>SPRING</i> (HASTELLOY) CONFIGURATION A (STANDARD):</p> <ul style="list-style-type: none"> • <i>D9,5 ball</i> • <i>opening pressure: 0,4 bar</i> <p>CONFIGURATION A + C:</p> <ul style="list-style-type: none"> • <i>D9,5 ball + spacer</i> • <i>opening pressure: 0,7 bar</i>

7 mm OUTPUT HOLE DIAMETER INJECTOR LENGHT OPTION	
<p>Preset lenghts injector</p>	<p>SHORT <i>Minimal lenght</i></p> <p>MEDIUM</p> <p>LONG</p> <p><i>Cut according to requirements</i></p>

3/8" - 1/2" INJECTION VALVE

CONNECTION FOR 10x14 HOSE OPTION

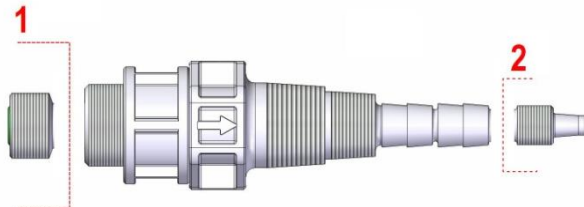

3/8" connection cutting (1) and D3 nozzle cutting (2)

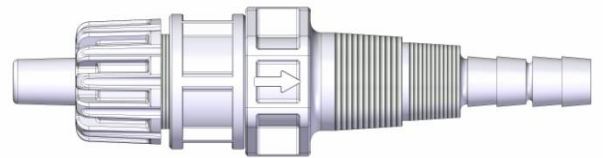

Valve overall view for tube 10x14

FIXATION KIT FOR TUBE 6x8 AND 10x14

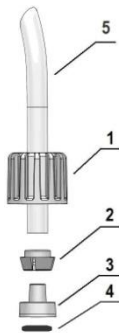

Kit fissaggio tubi 6 x 8



Kit fissaggio tubi 10 x 14

1. Nut
2. Bush
3. Nozzle
4. O-ring
5. Hose

INSTALLATION EXAMPLES

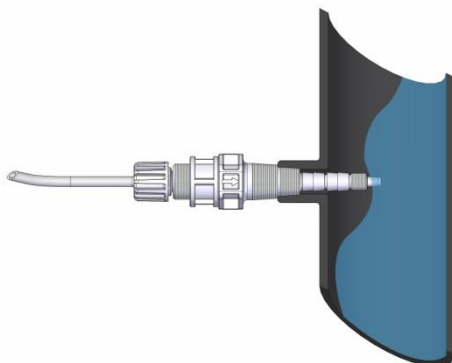

INSTALLATION SU ATTACCO 3/8"

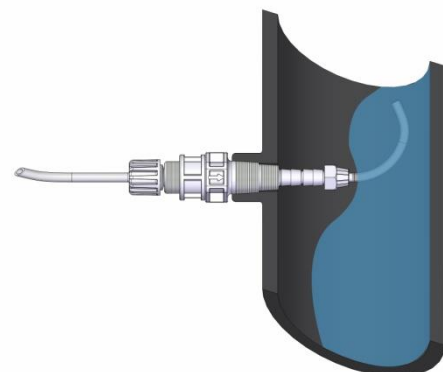

INSTALLATION ON 1/2" CONNECTION WITH ANTIFOAM 4x6 FLEXIBLE EXTENSION